



Catálogo Digital 2025

ECOMEX 

Sumário

| | | |
|---|--|----|
|  | Sobre a empresa..... | 03 |
|  | Linha Eco Design 3D I Vinílico SPC Click | 05 |
|  | Linha Eco Premium I Vinílico SPC Click..... | 09 |
|  | Linha Eco Hard I Vinílico LVT Colado..... | 13 |
|  | Linha Eco Hard Square I Vinílico LVT em Placa..... | 17 |
|  | Linha Eco Home I Vinílico LVT Colado..... | 21 |
|  | Linha Diamond I Vinílico em Manta..... | 26 |
|  | Linha Conductive I Vinílico em Manta..... | 28 |
|  | Linha Harmonic I Vinílico em Manta..... | 29 |
|  | Linha Ecoflex I Vinílico em Manta..... | 31 |
|  | Molduras Poliestireno..... | 32 |

Sobre a empresa

A ECOMEX iniciou sua trajetória no ramo da construção observando a necessidade do mercado em oferecer produtos de qualidade PREMIUM. Consolidada através do contato direto com clientes, lojistas revendedores, incorporadoras, engenheiros e arquitetos, a ECOMEX possui ampla expertise e foco na importação de produtos inovadores.

Neste momento, a ECOMEX oferece aos seus clientes diferentes opções em Pisos Vinílicos, possuindo modelos em formato de régua, em placas e também em mantas. Além dos revestimentos, comercializa também as molduras em poliestireno, que são utilizadas tanto como rodapés ou guarnições.

Um dos aspectos fundamentais de sua operação é a logística bem estruturada que nos permite receber todos os produtos diretamente através dos portos de SC.

Atualmente, possui equipe de representantes comerciais em diferentes regiões do Brasil, entre elas estão: RS, SC, PR, ES, SP, RJ, GO, MS, MT e DF e conta com distribuidoras parceiras em outras regiões.

REDES SOCIAIS



Qualidade comprovada

Todos produtos ECOMEX são fabricados com matéria prima de qualidade superior no segmento, contando com tecnologias avançadas permitindo uma performance diferenciada, atendendo a todas as normas, garantias e certificações internacionais de qualidade.

CERTIFICAÇÕES INTERNACIONAIS





LINHA

Eco Design 3D

LINHA

Eco Design 3D VINÍLICO SPC CLICK

Os pisos vinílicos SPC da linha Eco Design possuem a **tecnologia 3D** na superfície do produto. Essa técnica permite que as ranhuras e desenhos sejam **impressos em relevo**, proporcionando maior profundidade no design.

Com este processo de fabricação é possível chegar a uma textura realista e autêntica na superfície do piso, imitando fielmente a aparência e sensação tátil do material natural, como a madeira.

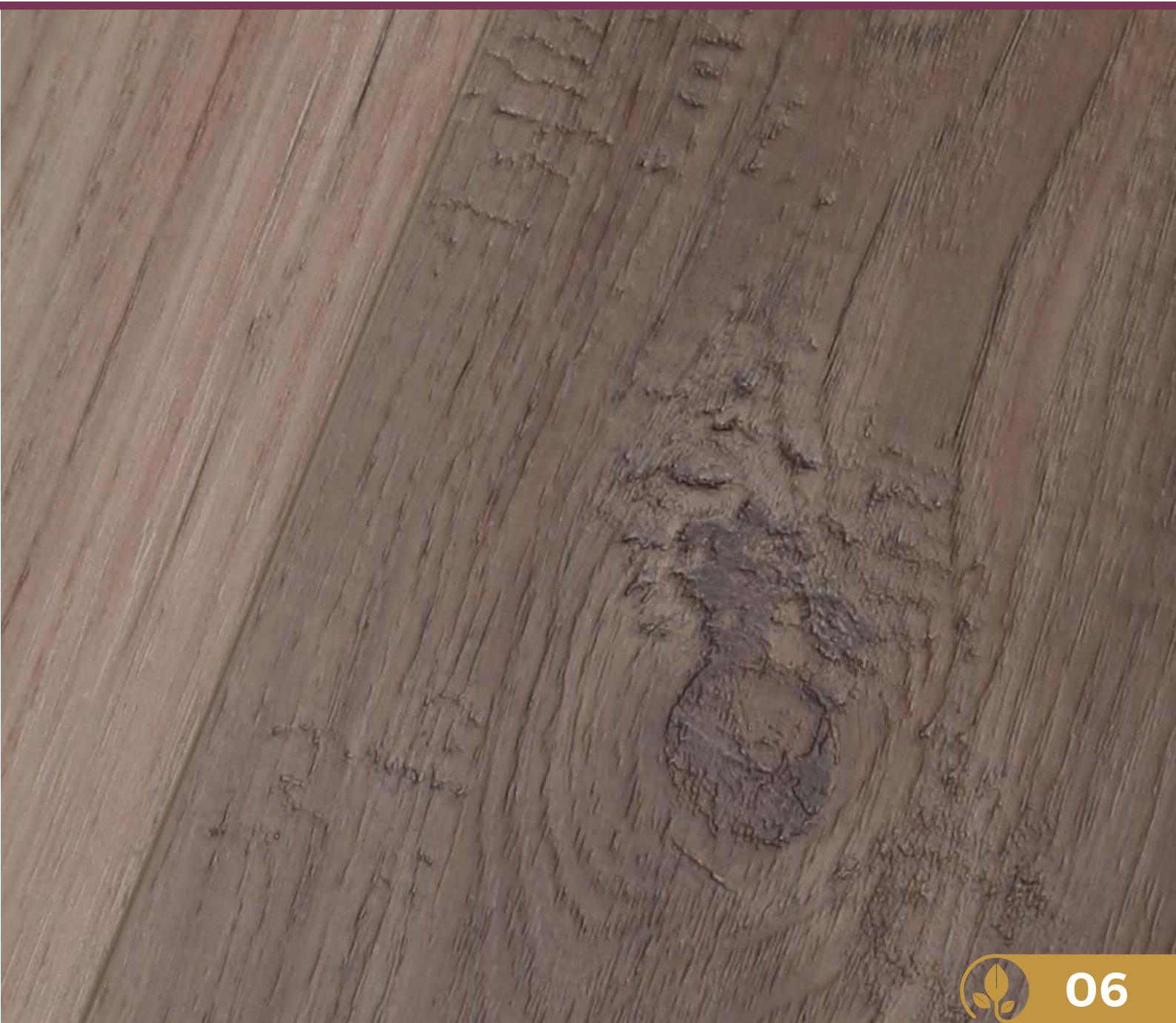

LINHA

Eco Design 3D VINÍLICO SPC CLICK



Chicago

189



Austin

190



Dallas

199



Nevada

200



Atlanta

201

- Formato: régua
- Instalação: sistema de encaixe New Click
- Tamanho da régua: 1520 X 228mm
- Espessura Total: 6,5mm
- Capa de Uso: 0,50mm
- Classificação de Uso: (23) Residencial Pesado / (32) Comercial Geral

- Réguas por caixa: 6 réguas (2,07936 m²)
- Caixas por Pallet: 90
- Pallet: 187,1424 m²
- Peso Caixa: 22,56 kg
- Peso (M²): 10,85 kg



LINHA

Eco Design 3D VINÍLICO SPC CLICK



*Textura realista com nós e veios da madeira.





LINHA

Eco Premium



O termo "**click**" refere-se ao sistema de instalação em que as peças do piso se encaixam por meio de um mecanismo de clique, dispensando o uso de cola ou outros adesivos. Este sistema proporciona uma obra silenciosa, rápida e sem sujeiras.

Os pisos vinílicos **SPC (Stone Plastic Composite)** são compostos por uma mistura de pó de pedra (carbonato de cálcio) e PVC (cloreto de polivinila). Essa combinação resulta em um piso com uma base rígida e altamente durável.



LINHA

Eco Premium

VINÍLICO SPC CLICK

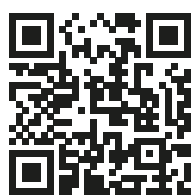
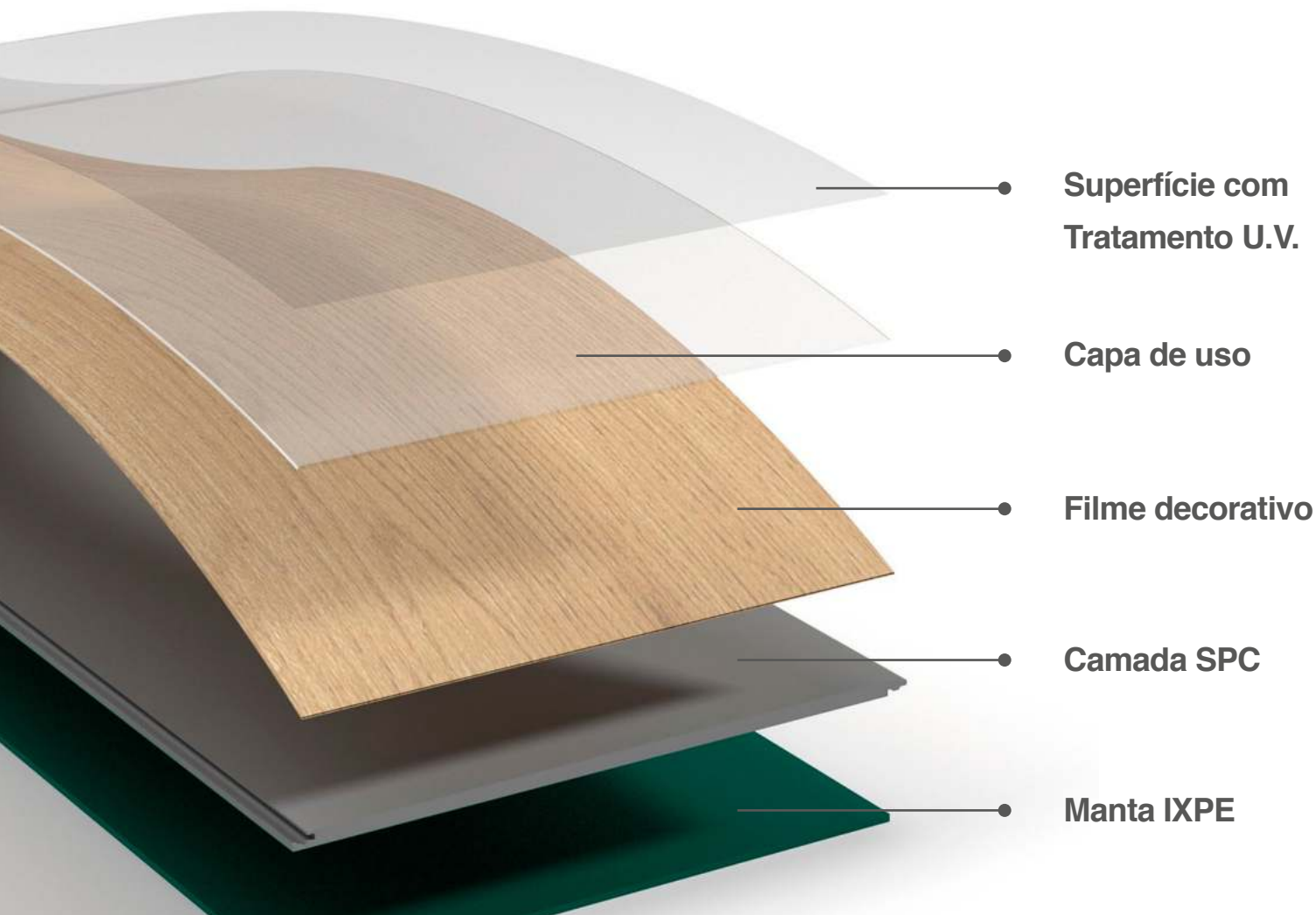

VEJA COMO INSTALAR
SEU PISO VINÍLICO
SPC CLICK 

- Formato: régua
- Instalação: sistema de encaixe Click
- Tamanho da régua: 1220 X 230mm
- Espessura Total: 5,5mm
- Capa de Uso: 0,30mm
- Classificação de Uso: (23) Residencial Pesado
/ (31) Comercial Moderado
- Réguas por caixa: 8 réguas (2,2448 m²)
- Caixas por Pallet: 68
- Pallet: 152,6464 m²
- Peso Caixa: 19,0600 kg
- Peso (M²): 8,46 kg



LINHA

Eco Premium

VINÍLICO SPC CLICK



Cannes

181



Paris

182



Troyes

183



Toulon

184



Marselha

185



Lyon

186



Calais

187



Metz

188





LINHA

Eco Hard



O piso vinílico **LVT (Luxury Vinyl Tile)**, feito a partir de PVC, possui um núcleo mais flexível e permite infinitas paginações. Na instalação dos Pisos Vinílicos Colados é obrigatória a preparação do contrapiso com massa autonivelante e utilização de cola específica para piso vinílico.





Valência

123



Barcelona

124



Sevilha

125



Madri

126



Vigo

193

- Formato: régua
- Instalação: cola
- Tamanho da régua: 1219,2 X 228,6mm
- Espessura Total: 3mm
- Capa de Uso: 0,55mm
- Classificação de Uso: (23) Residencial Pesado
/ (33) Comercial Pesado

- Réguas por caixa:
10 réguas (2,7870 m²)
- Caixas por Pallet: 102
- Pallet: 284,2833 m²
- Peso Caixa: 15 kg
- Peso (M²): 5,38 kg





Os pisos da Linha Eco Hard possuem **capa de uso 0,55 mm**, isto permite que eles sejam instalados em ambientes de tráfego moderado a intenso, como escritórios, lojas, áreas comerciais e até residências com alto fluxo de pessoas, tratando-se de um piso altamente resistente.



LINHA

Eco Hard Square

LINHA

Eco Hard Square VINÍLICO LVT COLADO



Toledo

- Formato: placa
- Instalação: cola
- Dimensões: 914,4 X 914,4 mm
- Espessura Total: 3mm
- Capa de Uso: 0,55mm
- Classificação de Uso: (23) Residencial Pesado
/ (33) Comercial Pesado
- Placas por caixa: 6 unid. (5,0167 m²)
- Caixas por Pallet: 40
- Pallet: 200,6706 m²
- Peso Caixa: 27,55 kg
- Peso (M²): 5,49 kg



LINHA

Eco Hard Square

VINÍLICO LVT COLADO



Maiorca

127



Toledo

140

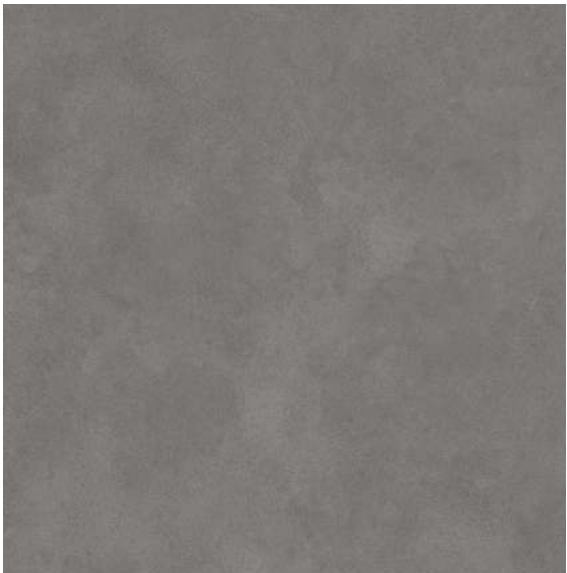

Bilbao

194

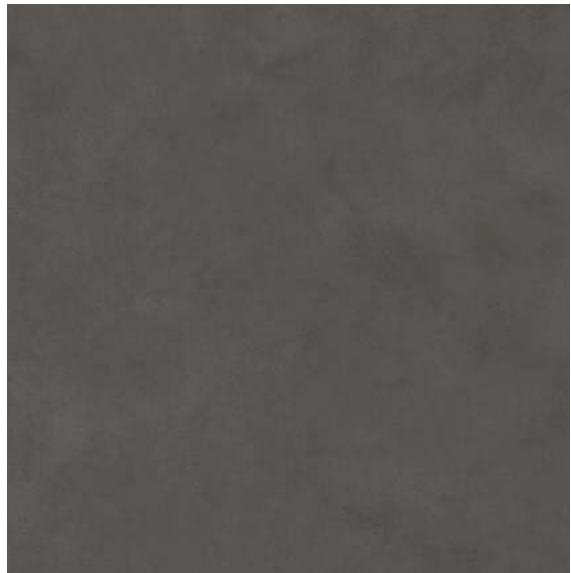

Córdoba

195



Cartagena

196



LINHA

Eco Hard Square VINÍLICO LVT COLADO



Lisboa

197



Porto

198



- Formato: placa
- Instalação: cola
- Dimensões: 609,6 X 609,6 mm
- Espessura Total: 3mm
- Capa de Uso: 0,55mm
- Classificação de Uso: (23) Residencial Pesado
/ (33) Comercial Pesado
- Placas por caixa: 10 unid. (3,7161 m²)
- Peso Caixa: 22,6 kg





LINHA

Eco Home



Nantes

128



Vienne

129



Dijon

130



Versalhes

131



Lyon

132



Lille

134



Nice

191



Bize

192



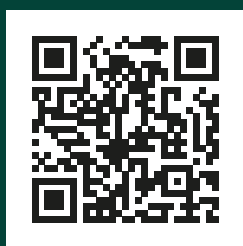
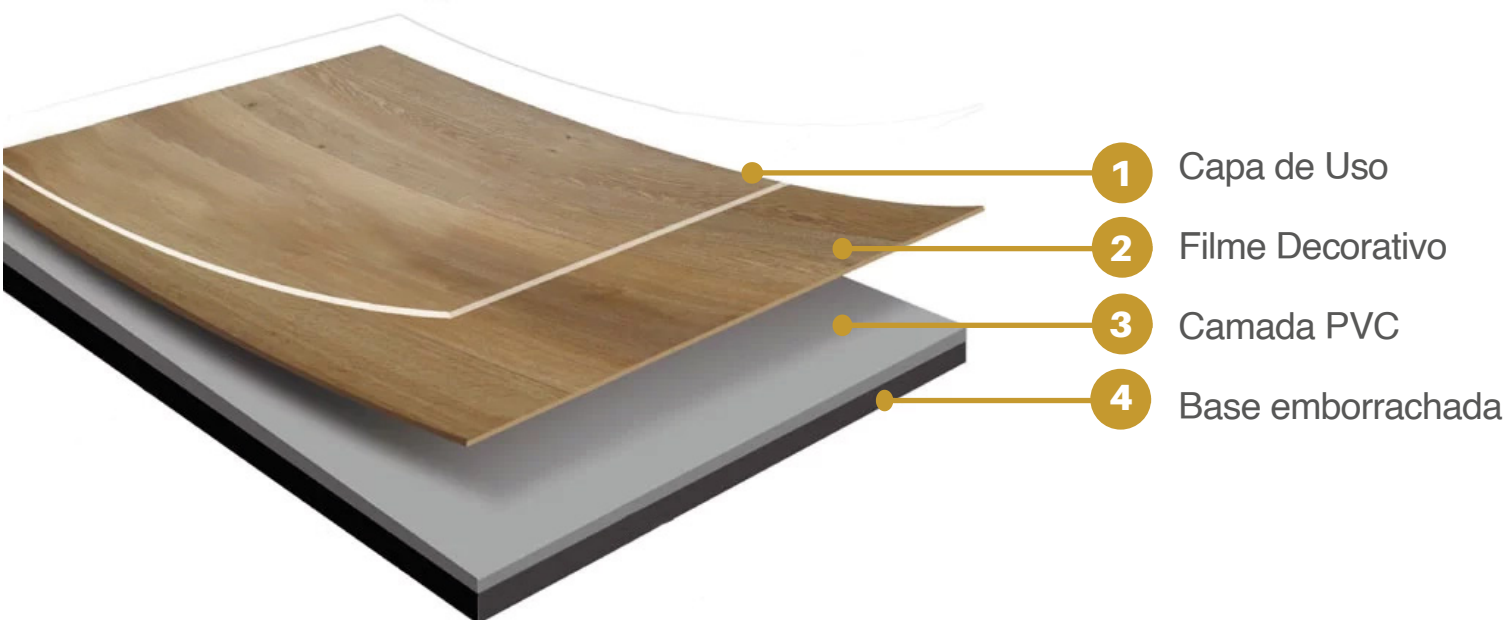

**VEJA COMO INSTALAR
SEU PISO VINÍLICO
LVT COLADO** 

- Formato: régua
- Instalação: cola
- Tamanho da régua: 1219,2 X 228,6mm
- Espessura Total: 2mm
- Capa de Uso: 0,20mm
- Classificação de Uso: (22) Residencial Geral
- Réguas por caixa:
16 réguas (4,4593 m²)
- Caixas por Pallet: 90
- Pallet: 401,3411 m²
- Peso Caixa: 18,35 kg
- Peso (M²): 4,11 kg





PISOS VINÍLICOS EM

Mantas

PISOS VINÍLICOS EM

Mantas

O piso vinílico em manta é um revestimento flexível e resistente, feito de PVC (policloreto de vinila), fabricado em forma de rolos. Sua aplicação fica visualmente mais uniforme, já que não possuem rejuntas em sua instalação. Por esta razão, este tipo de piso não acumula poeira, e também é resistente à infiltração de líquidos.

Os pisos em manta são opções versáteis e eficazes para projetos que exigem soluções específicas e de alta performance, como áreas hospitalares, escolas e creches.

O piso em manta pode ser classificado em homogêneo (composto por uma única camada) ou heterogêneo (composto por várias camadas), podendo oferecer um padrão de instalação direcional ou não direcional.





ESTRUTURA MANTA HOMOGÊNEA

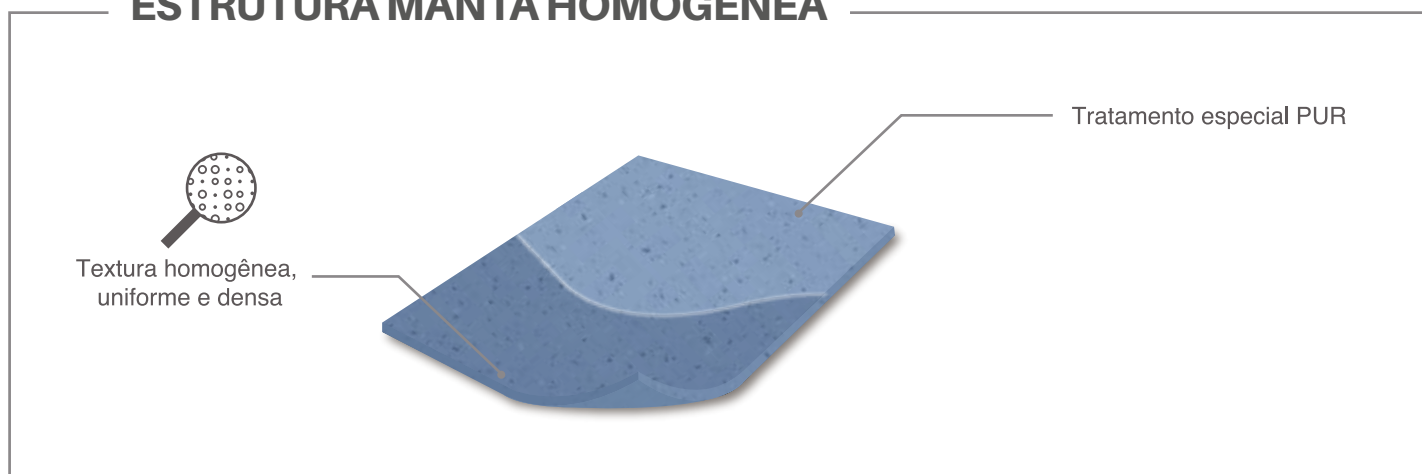

■ Cor a pronta-entrega ■ Cor sob encomenda



321

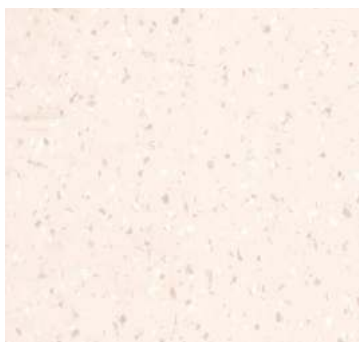

322



323



324



325



326

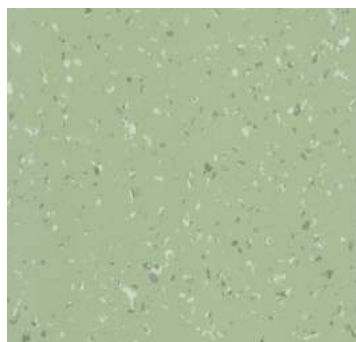

327



328



Conductive

LINHA BLOCO CIRÚRGICO

MANTAS HOMOGÊNEAS

Rolo: 2m x 20 m x 2mm

Os pisos da linha **Conductive** são feitos de materiais que têm propriedades condutoras, permitindo que a eletricidade estática seja rapidamente dissipada para o solo. São essenciais para ambientes hospitalares como centros cirúrgicos, laboratórios, UTIs e centros de radiologia, porque asseguram a dissipação de descargas estáticas, evitando danos a equipamentos eletrônicos, além de proteger paciente e equipe médica.

■ Cor a pronta-entrega ■ Cor sob encomenda

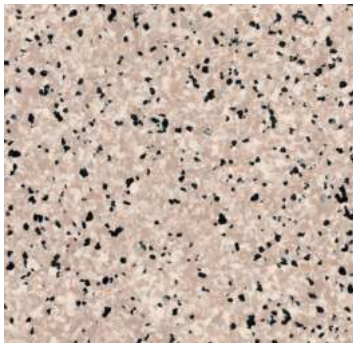

451

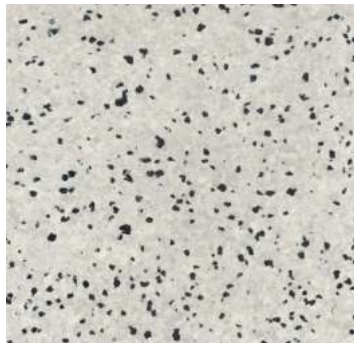

452

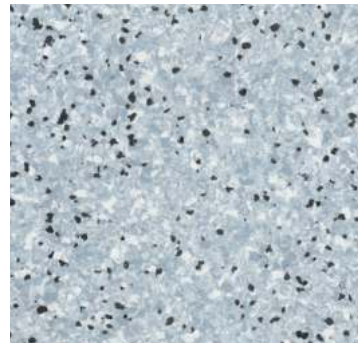

453

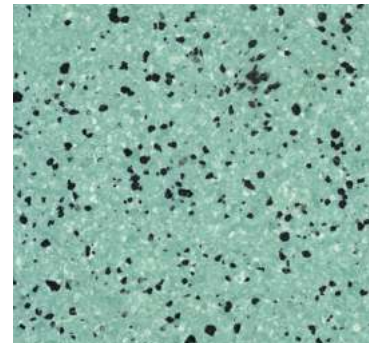

454



Os pisos heterogêneos da linha **Harmonic** são indicados tanto para áreas residenciais, quanto áreas comerciais. A instalação em manta permite a criação de uma superfície contínua, sem emendas visíveis, o que resulta em uma aparência mais uniforme e limpa, o que é vantajoso em ambientes como escolas, creches, pequenas lojas e escritórios.



ESTRUTURA MANTA HETEROGÊNEA

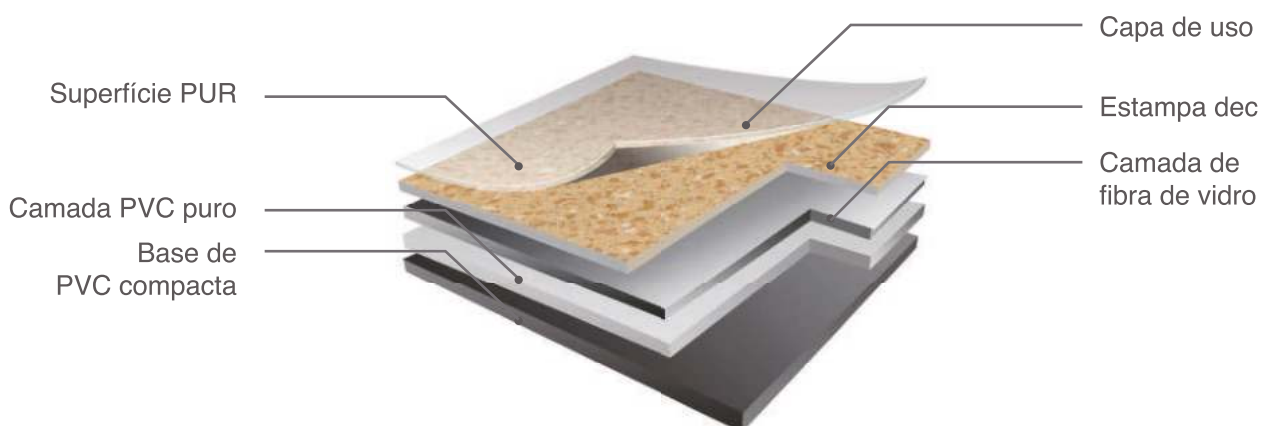

Harmonic

LINHA RESIDENCIAL / CORPORATIVA

MANTAS HETEROGÊNEAS

Rolo: 2m x 20 m x 2mm - capa de uso 0,70mm

■ Cor a pronta-entrega ■ Cor sob encomenda



231

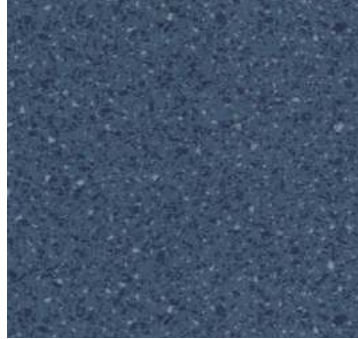

232



233

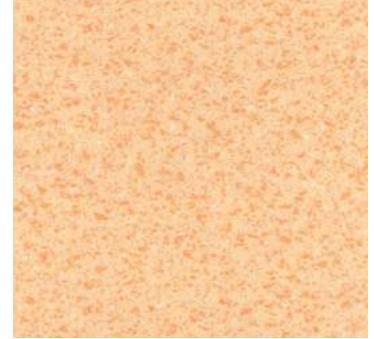

234



235



236



237

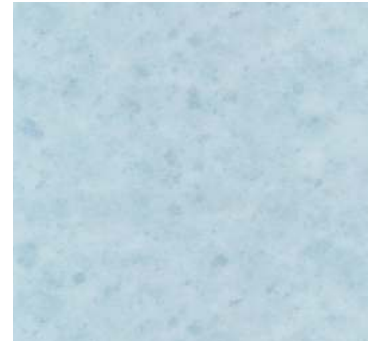

238



239



240





Os pisos heterogêneos da linha **Ecoflex** são indicados para áreas residenciais. Com estampa amadeirada, reproduz com fidelidade a superfície da madeira. A ausência de emendas minimiza a chance de infiltração de água e sujeira, facilitando a manutenção e prolongando a vida útil do piso.

■ Cor a pronta-entrega ■ Cor sob encomenda



151



152



153



154





MOLDURAS

POLIESTIRENO



Poliestireno

As molduras da Linha Eco Premium são produzidas em poliestireno (PS) e são utilizadas como rodapés ou guarnição. Possibilitam ser aplicadas em diferentes superfícies como alvenaria, paredes em gesso, entre outras.

Produzidas a partir de uma resina termoplástica dura, são molduras altamente resistentes e duráveis.

Benefícios



Resistente
a Cupim



Não Propaga
Chamas



Economia
pela praticidade



Resistente
a Água



Fácil
Limpeza



Instalação
Rápida

MOLDURAS

Poliestireno

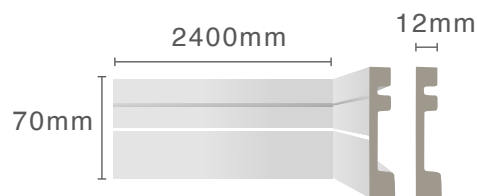

**MOLDURA BRANCA
COM FRISO | 7CM**
Ref. 92

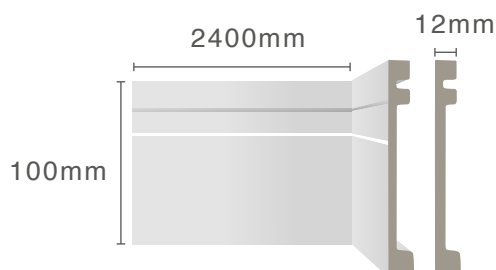

**MOLDURA BRANCA
COM FRISO | 10CM**
Ref. 93

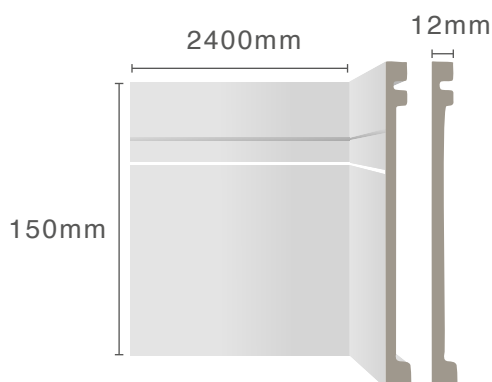

**MOLDURA BRANCA
COM FRISO | 15CM**
Ref. 94



**MOLDURA BRANCA
LISA | 7CM**
CÓD. 95

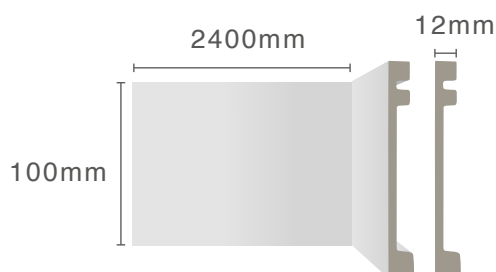

**MOLDURA BRANCA
LISA | 10CM**
Ref. 96

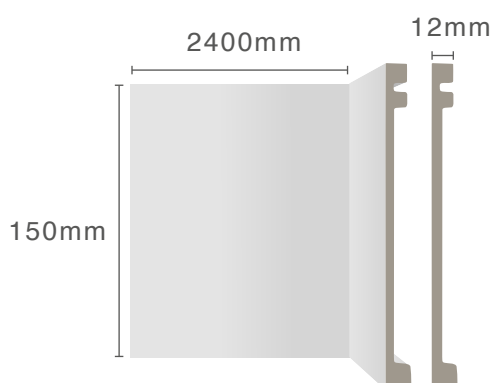

**MOLDURA BRANCA
LISA | 15CM**
Ref. 97



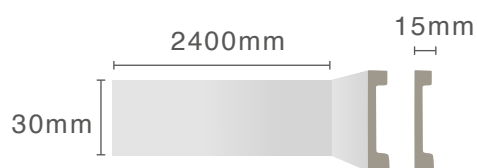
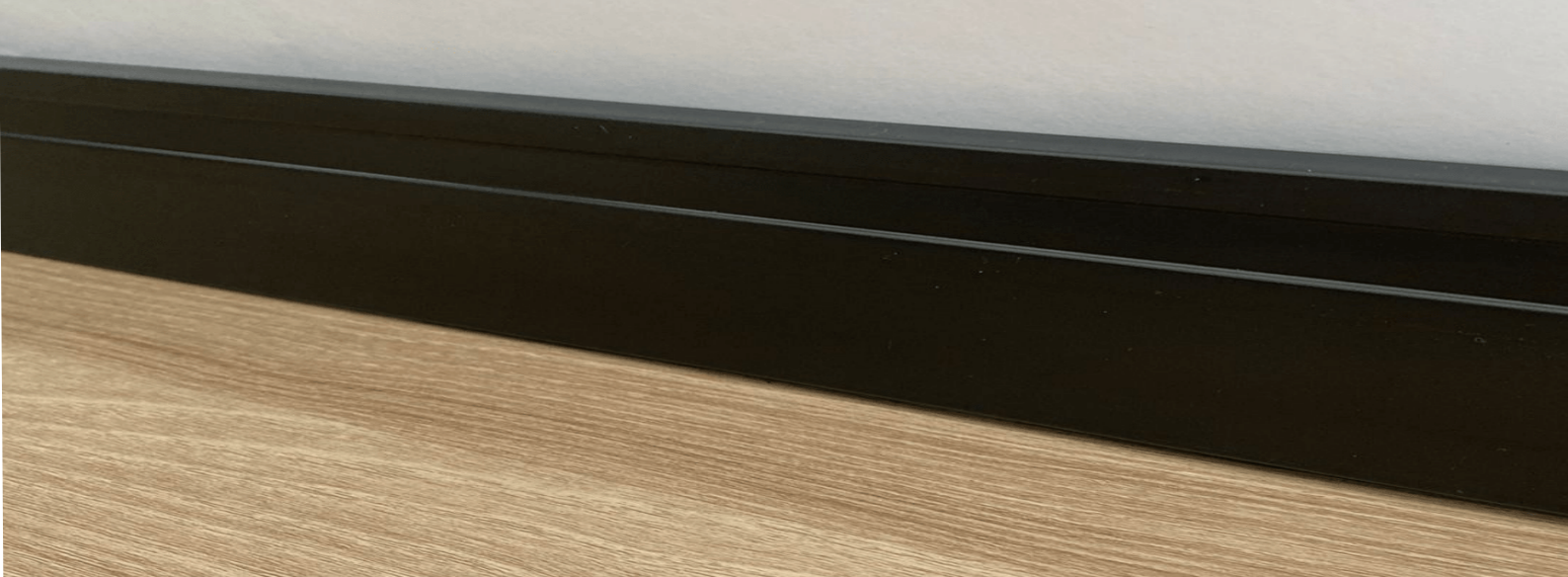

MOLDURA BRANCA
LISA | 3CM
Ref. 121

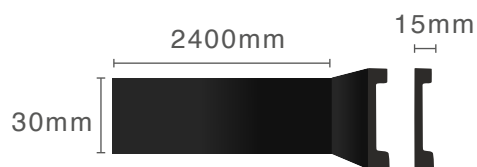

MOLDURA PRETA
LISA | 3CM
Ref. 139

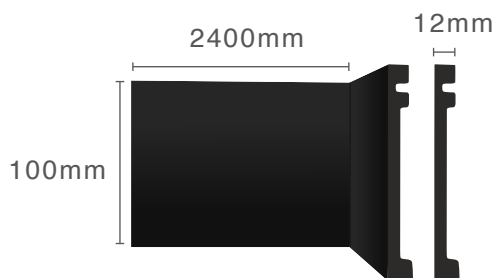

MOLDURA PRETA
LISA | 10CM
Ref. 202

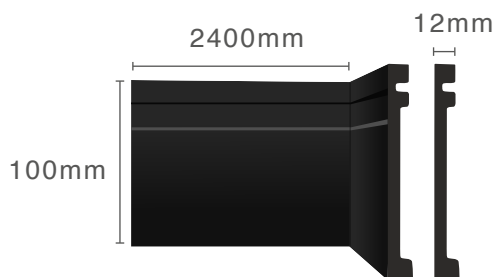

MOLDURA PRETA
COM FRISO | 10CM
Ref. 119

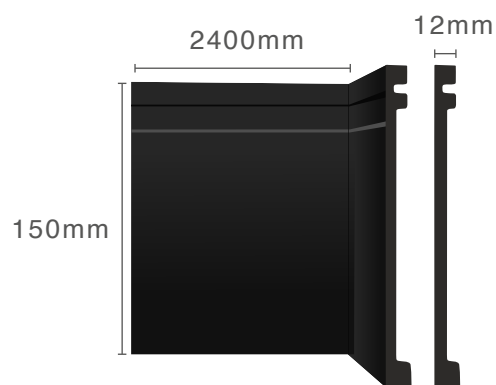

MOLDURA PRETA
COM FRISO | 15CM
Ref. 120



Sobre a Garantia

Evite perder sua Garantia Ecomex. Para instalação e conservação do produto siga todas orientações do fabricante que estão disponíveis em nosso site www.ecomexbrasil.com.br/manuais. Através do site você terá acesso ao Boletim Técnico do Produto, Certificado de Garantia e Manuais de Instalação.

As regras básicas de instalação também estão descritas na embalagem do produto, incluindo as normas da ABNT específicas do revestimento.

ECOMEX 

Mais informações?
Entre em contato:



CLIQUE AQUI



(51) 3466-1588

www.ecomexbrasil.com.br

Nos acompanhe também nas redes sociais!



ecomexbrasil